

LINAX 4000L

14081B
2/12.00

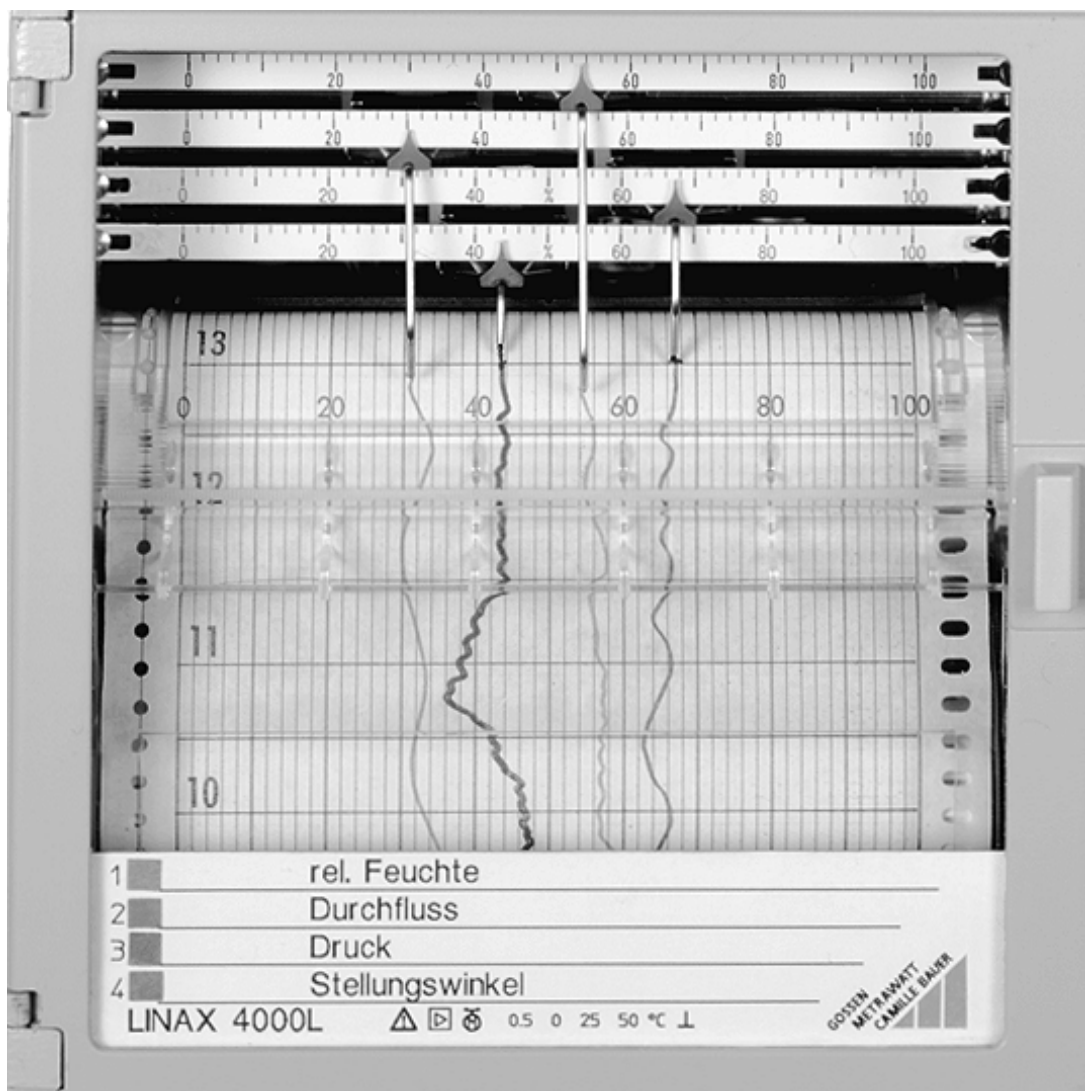

Contents

	Page
1 Installation and startup	3
1.1 Scope of delivery	3
1.2 Choosing the mounting site	3
1.3 Installation	3
1.4 Connection	4
1.4.1 Connecting the input signals	4
1.4.2 Connecting the power supply	4
1.5 Chart loading	5
1.5.1 Recording table for roll chart	5
1.5.2 Recording table for fanfold chart	5
1.6 Installing the fiber pen insert	6
1.7 Switching the recorder on	6
1.8 Positioning the recording chart	6
2 Operation	6
2.1 Removing the recording chart	6
2.2 Removing the recording chart from the take-up roll	6
2.3 Changing the chart speed	7
2.4 Select response time	7
3 Reconfiguration	8
3.1 Changing the measuring ranges	8
3.1.1 Hardware matching by means of jumpers	8
3.2 Set zero and calibrate upper range limit	8
3.3 Replacing scales	9
3.4 Replacing the label for the measuring points	9
4 Maintenance	9
4.1 Fuse replacement	9
5 Technical data	10
6 Packing	11

Important information for your safety!
It must absolutely be read and followed!

A condition of correct and safe operation of the continuous-line recorder LINAX 4000L is that it is transported and stored in a suitable manner, competently installed and started as well as correctly operated and carefully serviced.

Only those persons must work on the recorder who are familiar with installation, startup, operation and servicing of comparable equipment and who have the qualification required for their work.

The contents of these operating instructions and the safety notes affixed to the unit are to be observed.

The regulations, standards and directives mentioned in these operating instructions are for the Federal Republic of Germany. When using the recorder in other countries, relevant national rules must be followed.

The recorder is constructed and tested according to DIN EN 61 010-1 "Safety requirements for electronic measuring instruments", it left the factory in safe and proper condition. To maintain this condition and to ensure safe operation, the safety notes in these operating instructions with the heading "Caution" must be followed. Otherwise, persons could be endangered and the unit itself as well as other equipment and facilities could be damaged.

If the information contained in these operating instructions should not be sufficient in certain cases, the GOSSEN-METRAWATT Service will be glad to provide further information.

Reference symbols in the text

<Key> Designation of the keys in the display and control panel

The information "right", "left" or "top", "bottom" – unless otherwise stated – is on the understanding that the viewer looks at the front.

Applications and brief description

The LINAX 4000L is a microprocessor-controlled continuous-line recorder with 1 to 4 line channels,
– 1 to 3 line channels and a printer channel.
The measuring channels are electrically isolated from each other and are floating. The recorder is connected to transducers and is served to measure proces-related signals.

1 Installation and startup

1.1 Scope of delivery

(see figure 1)

The continuous-line recorder LINAX 4000L comes with:

- 1 copy of operating instructions
- 2 fasteners **Be**
- 1 fiber pen insert **Fe** per measuring channel
- 1 pack of fanfold chart **Fp** or 1 roll chart **Sr**
- Depending upon the order, the respective number of screw-plug terminals **Sk** and reading ruler(s).

- Be** Fastener
- Fe** Fiber pen inserts
- Fp** Fanfold chart
- Sk** Screw-plug terminals
- Sr** Chart roll

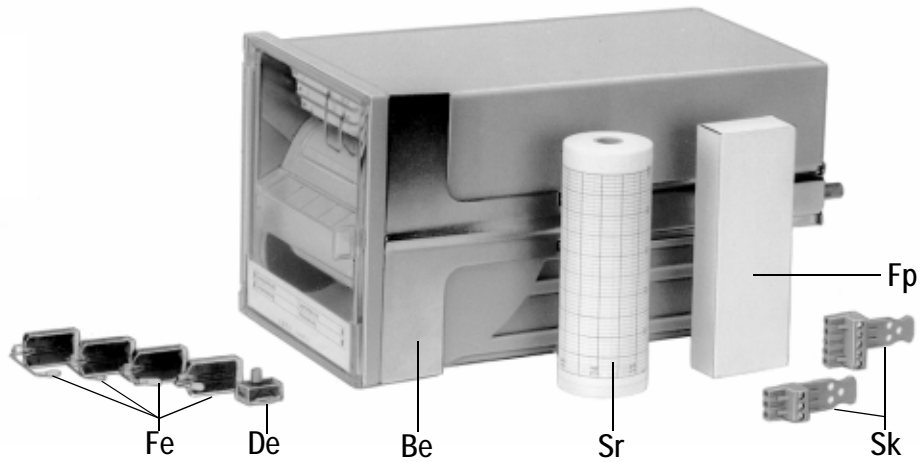

Figure 1 Scope of delivery of the LINAX 4000L

1.2 Selecting the mounting site

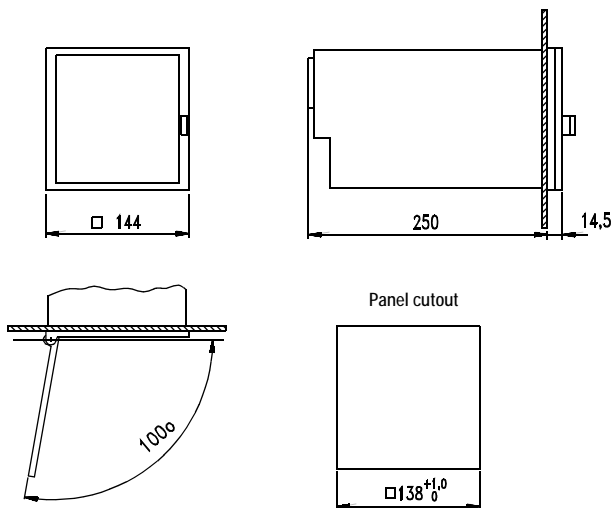

Figure 2 Dimensional drawing LINAX 4000L (dimensions in mm)

Position of use	Inclination to the side $-30^{\circ} \dots 0 \dots +30^{\circ}$ Inclination to the rear 20° Inclination to the front 20°
Ambient temp.	$0 \dots 50^{\circ}\text{C}$
Relative humidity	$\leq 75\%$ annual average, max. 85% . Prevent dewing!

1.3 Installation

(see figure 2 and figure 3)

Installation in switchboards

1. Insert the recorder into the switchboard from the front.
2. At the sides of the case, slide the fasteners **Be** into the guide grooves (see figure 3).

Note

The fasteners **Be** are suited for side-by-side mounting in horizontal or vertical direction.

3. After aligning, equally tighten the fasteners **Be**.

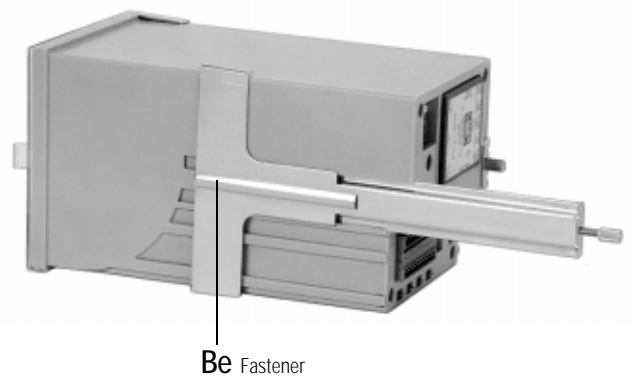

Figure 3 Mounting the fasteners

Installation in grid frames

1. Fasten 4 each centering angle bracket (Ordering number A416A) on the grid frame.
2. Slide the fasteners **Be** into the guide grooves at the sides of the case (see figure 3).
3. After alignment, equally tighten the fasteners **Be**.

1.4 Connection

(see figure 4)

! Caution

The connection between the protective conductor connection and a protective conductor must be made prior to all other connections.

The unit can become dangerous when the protective conductor inside or outside the unit is interrupted or when the protective conductor connection is undone.

The recorder must only be operated in installed condition.

A power line connection switch of sufficient switching capacity, which permits all-pole disconnection of the recorder from the power line, must be provided within reach of the mounting site. It must not annul the protective effect of the protective conductor.

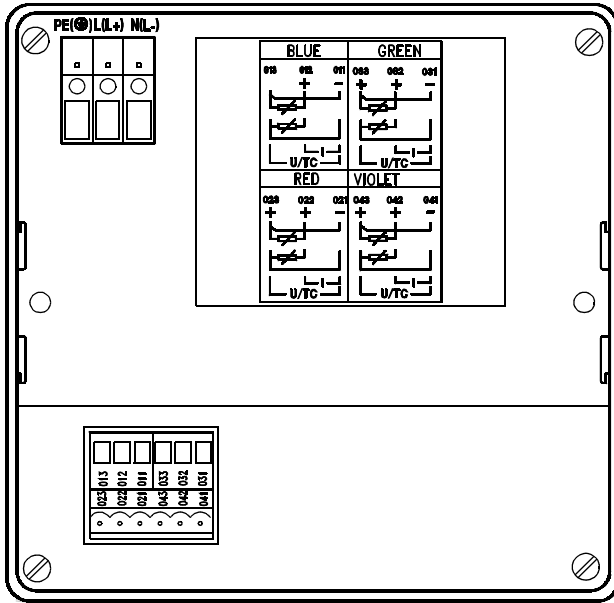
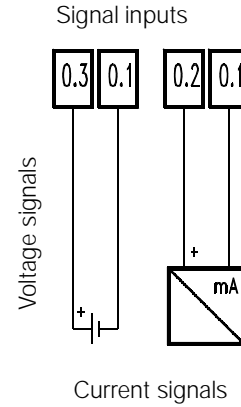

Figure 4 Rear panel and wiring diagrams

1.4.1 Connecting the input signals

- Fasten the signal leads in the screw-plug terminals, maximum cross section $2 \times 1 \text{ mm}^2$.



1.4.2 Connecting the power supply

- Fasten the power supply lines, max. cross section $1 \times 4 \text{ mm}^2$ or $2 \times 1.5 \text{ mm}^2$, in the screw terminals. The cross section of the protective conductor must at least correspond to the cross section of the line power cable.

1.5 Chart loading

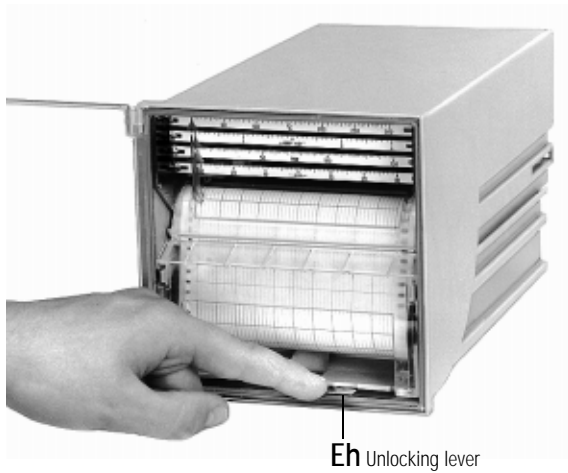

Figure 5 Unlocking the recording table

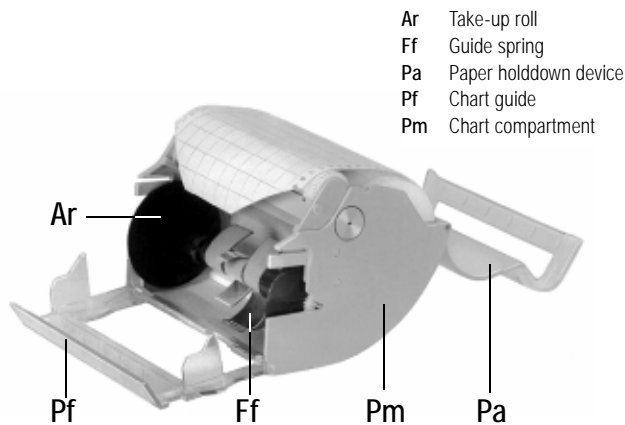

Figure 6 Recording table for roll chart

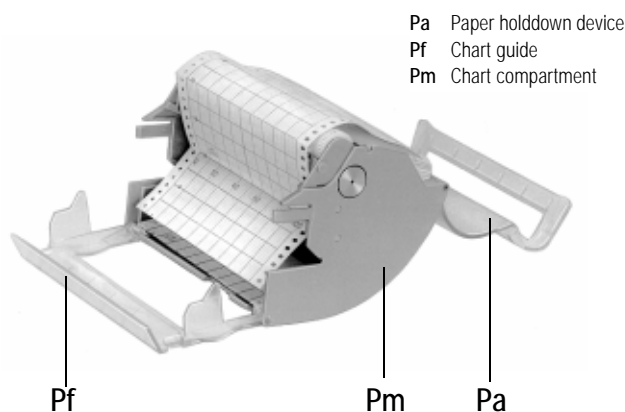

Figure 7 Recording table for fanfold chart

1.5.1 Recording table for roll chart

(see figure 5 and figure 6)

1. Unlock the recording table: Press the unlocking lever **Eh** downwards (see figure 5). The recording table tilts to the front. Remove the recording table.
2. Unfold the paper holddown device **Pa**.
3. Place the chart roll into the chart compartment **Pm**.
4. Pull the front end of the chart up to the pin platen and place the perforation onto the pins of the platen. Make sure chart and pin platen are in parallel!
5. Fold the paper holddown device **Pa** back.
6. Unfold the chart guide **Pf**.
7. Insert the take-up roll **Ar**
8. Fold the chart guide **Pf** back.

Note

When the recording table has been inserted into the recorder, the chart automatically winds onto the take-up roll.

9. Swing the recording table into the chassis until it engages.

1.5.2 Recording table for fanfold chart

(see fig. 5, fig. 6 and fig. 7)

When changing the recording table for roll chart to fanfold chart, remove the guide spring **Ff** (see figure 6).

1. Unlock the recording table: Press the unlocking lever **Eh** downwards (see figure 5). The recording table tilts to the front. Remove the recording table.
2. Unfold the paper holddown device **Pa**.
3. Place the fanfold pack into the chart compartment **Pm**.
4. Unfold the chart guide **Pf**.
5. Pull the front end of the chart up to the pin platen and place the perforation onto the pins of the platen. Two folded layers must rest on the bottom of the chart compartment. Make sure chart and pin platen are in parallel!
6. Fold the paper holddown device **Pa** back.
7. Fold the chart guide **Pf** back.
8. Swing the recording table into the chassis until it engages.

1.6 Installing the fiber pen insert

1. Fold the scales up.
2. Install the fiber pen insert / print insert according to figure 8.

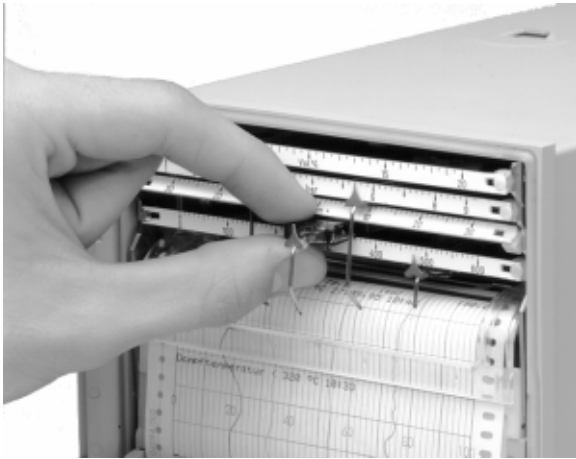

Figure 8 Installing the fiber pen insert

1.7 Switching the recorder on

Caution

Prior to switching the power supply on, verify that the operating voltage of the recorder (see nameplate) and the supply voltage agree.

A power line connection switch of sufficient switching capacity, which permits all-pole disconnection of the recorder from the power line, must be provided within reach of the mounting site. It must not annul the protective effect of the protective conductor.

1.8 Positioning the recording chart

(see figure 9)

1. Press the lower grip boards of the recording table to the rear. The recording chart is transported with increased speed in the direction of flow.
2. Release the grip boards when the desired time line is reached.

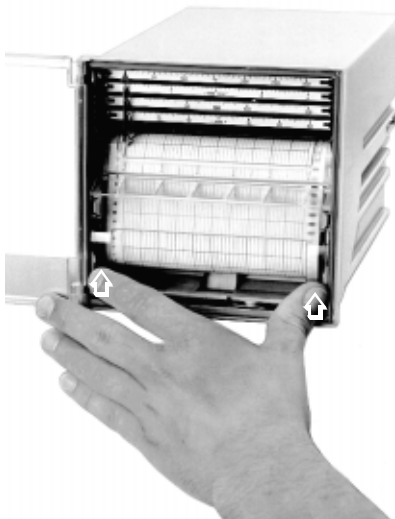

Figure 9 Positioning the recording chart

2 Operation

2.1 Removing the recording chart

(see figure 10)

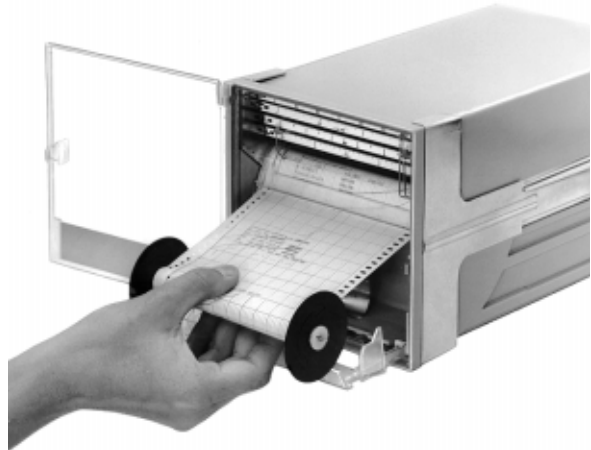

Figure 10 Removing the recording chart

The rec. table may be left in the unit when removing the chart.

Recording table for chart rolls

1. Unfold the chart guide downwards.
2. Remove the take-up roll.
3. Eventually separate the chart at the tear-off edge.

Recording table for fanfold chart

1. Unfold the chart guide downwards.
2. Remove the recording chart.
3. Eventually separate the chart at a fold.

Note

Two folded layers of the chart must rest in the chart compartment.

2.2 Removing the rec. chart from the take-up roll

(see figure 11)



Figure 11 Removing the recording chart from the take-up roll

1. Turn the flange without drive pinion through 45° and remove it from the take-up roll.
2. Grip the chart as shown in figure 11 and pull it off the axle.
3. Re-attach the right flange to the take-up roll and secure it by turning it through 45°.
4. Insert the take-up roll into the recording table. The drive pinion must be on the right side.
5. Close the chart guide.

2.3 Changing the chart speed

The chart speed can be selected via the keys A, B and C of the display and control panel. The associated LEDs are switched on and off with these keys. The combination of the LED states signals the active speed.

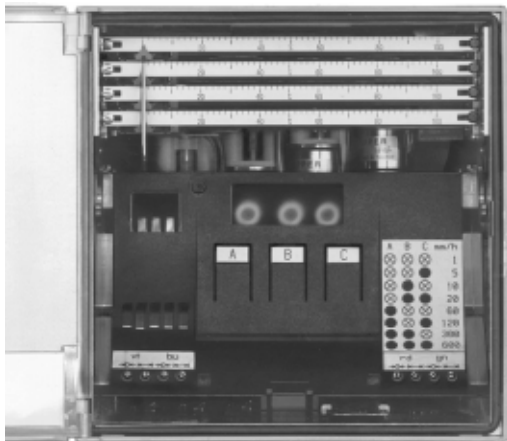

Figure 12 Changing the chart speed

1. Unlock recording table: press locking lever **Eh** down (see figure 5). Recording table swivels to the front.
2. Remove recording table.
3. Select chart speeds via the keys **A**, **B** and **C**.

A	B	C	Key
○	○	○	0/1 mm/h
○	○	●	5 mm/h
○	●	○	10 mm/h
○	●	●	20 mm/h (Basic setting)
●	○	○	60 mm/h
●	○	●	120 mm/h
●	●	○	300 mm/h
●	●	●	600 mm/h

Legend: ○ LED off ● LED on

4. Replace recording table.

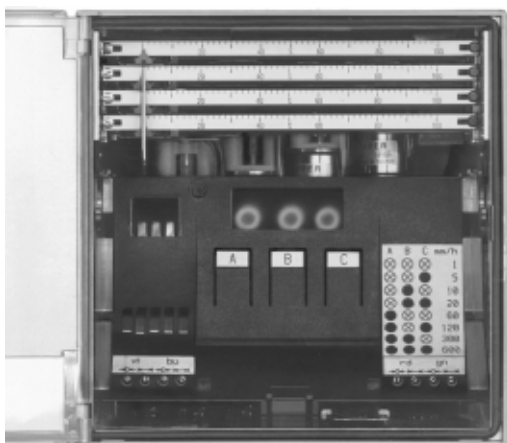

Figure 13 Select response time

2.4 Select response time

(see figure 13)

The response time of the measuring systems can be selected for each channel. The response time is defined as the time that is required by the measuring system to travel from 10 % to 90 % of the scale length with leap change of the measuring signal from 0 % to 100 %.

The setting behavior of the LINAX 4000L is linear. The revolution of the system motor is changed with the selection of the response time.

1. Unlock recording table: press locking lever **Eh** down (see figure 5). Recording table swivels to the front.
2. Remove recording table.
3. Press the keys **A** and **C** of the display and control panel simultaneously. The LED above the key **A** flashes slowly.

A	B	C	Key
○	○	○	Channel violet
○	○	●	Channel blue
○	●	○	Channel red
○	●	●	Channel green

Legend: ○ LED off ● LED on ○ LED flashes slowly

4. Select measuring channel with the keys **B** and **C**.
5. Press the key **A** of the display and control panel again. The LED above the key **A** flashes quickly.
6. Select the response time with the keys **B** and **C**. The following response times can be selected:

A	B	C	Key
○	○	○	2 s (Basic setting)
○	○	●	5 s
○	●	○	20 s
○	●	●	60 s

Legend: ○ LED off ● LED on ○ LED flashes quickly

7. Press the key **A**, the selected response time is stored. The LED above the key **A** flashes slowly.
8. Select next channel. Repeat the steps 4 and 5.
9. Press the keys **A** and **C** simultaneously. The LEDs show the active chart speed.
10. Replace recording table.

3 Reconfiguration

3.1 Changing measuring ranges

Standard version

The recorder is supplied with 2 measuring range settings:

1. 0 ... 20 mA / 0 ... 10 V for all channels
2. 4 ... 20 mA for all channels

When changing the measuring range the hardware must be matched by means of jumpers.

3.1.1 Hardware matching by means of jumpers (see figure 14 and 15)

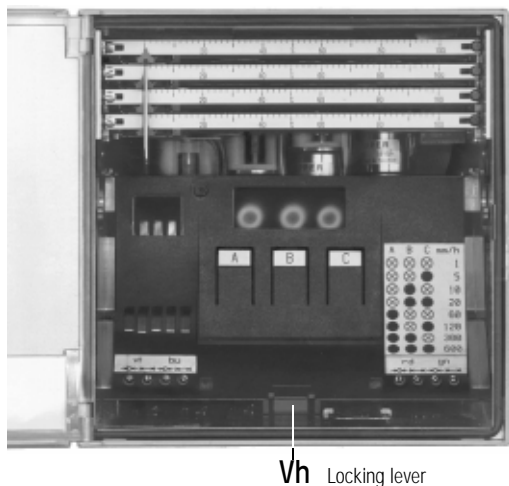

Figure 14

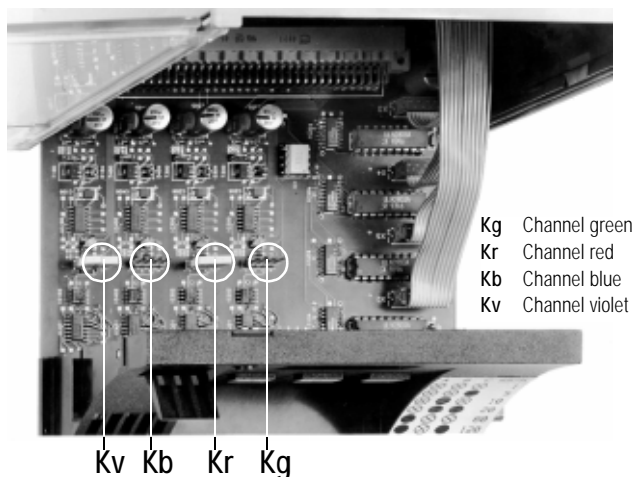

Figure 15 Electronic unit withdrawn

Withdraw electronic unit

1. Unlock recording table: press locking lever **Eh** down (see figure 5). Recording table swivels to the front.
2. Remove recording table.
3. Lift locking lever **Vh** (see figure 14) and withdraw the module simultaneously.
4. Withdraw the electronic unit to such an extent that the jumpers are easily accessible (see figure 15).
5. Plug jumpers for the measuring range 0 ... 20 mA / 0 ... 10 V
Remove jumpers for the measuring range 4 ... 20 mA

6. Slide-in electronic unit.
7. Replace recording table.

3.2 Set zero and calibrate the upper range limit (see figure 16)

For the blue and violet channels, each two potentiometers (at the left bottom) are accessible in the display and control panel.

For the red and green channels, each two potentiometers (at the right bottom) are accessible in the display and control panel.

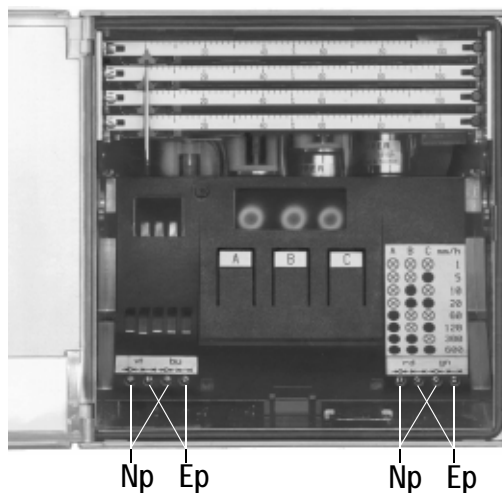

Figure 16 Display and control panel with potentiometer

The left potentiometer is for zero setting and the right potentiometer for calibration of the upper range limit (see figure 16). For zero setting, a bipolar voltage and/or current generator is required.

1. Connect the power supply and switch on.
2. Connect the generator and apply the lower limit which adjusts the recording pen tip to the zero line of the chart.
3. Adjust the scale to the pen tip.
4. Set the generator to the lower limit.
5. Unlock recording table: press locking lever **Eh** down (see figure 5). Recording table swivels to the front.
6. Remove recording table.
7. Set the pen tip to the beginning of the scale by means of the zero potentiometer.
8. Preset the upper range limit with the generator.
9. Set the pen tip to the end of the scale by means of the final value potentiometer.
10. Replace recording table.

3.3 Replacing scales (see figure 17)

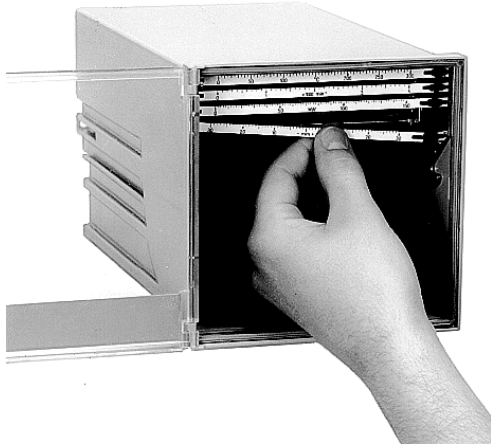

Figure 17 Replacing scales

1. Withdraw the fiber pen inserts.
2. Undo the scale screws at left.
3. Slide the scales to the right and disengage them from the scale screw.
4. Remove the scales to the left.
5. Install the scales in reverse order.
6. Install the fiber pen inserts.
7. Check the measuring system zero with beginning of scale. See zero setting.

3.4 Replacing the label for the measuring points (see figure 18)



Figure 18 Replacing the label for the measuring points

- Remove the flexible label for the measuring points from its holder and replace it with a new one.

4 Maintenance

4.1 Fuse replacement (see figure 19)

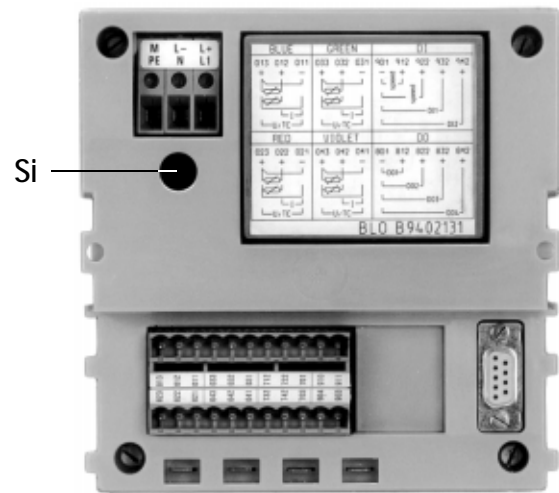

Figure 19 Replacing fuse Si

! Caution

Make sure that replacement fuses are of the specified type and the specified nominal current rating only. The use of mended fuses or shorting of the fuse holder is not permissible.

Live parts can be exposed when opening covers or removing parts, except where this is possible manually. Also connection points may be live.

1. Unscrew the fuse holder.
2. Replace fuse Si with a new one.
3. Replace the fuse holder.

Fuse values

230 V	M 0.16 C
115 V	M 0.315 C
24 V	M 1.6 E

5 Technical data

Applied rules and standards

A) International standards

IEC 484	Potentiometric recorders
IEC 1010-1	Electrical safety (test voltages)
IEC 664	Overvoltage category, degree of pollution
IEC 66-2-6	Mechanical stress (vibrations)
IEC 68-2-27	Mechanical stress (shock)
IEC 529	Degrees of protection provided by enclosures
IEC 801, EN 60801	Immunity to interference of electromagnetic influences
EN 55011	Radio interference suppression
EN 61010	Safety requirements of measurement and control equipment
IEC 721-3-3	Climatic environmental conditions
IEC 742	Classification VDE 0551 safety transformers

B) German standards

DIN 43802	Scales
DIN 16234	Recording paper
DIN 43831	Cases

Symbols and their meaning

Symbol	Meaning
X1n	Lower range limit nominal range
X2n	Upper range limit nominal range
X2n – X1n	Range span nominal range

Analog inputs and measuring ranges

DC current	0...20 mA; Ri = 40 Ω 4...20 mA; Ri = 50 Ω
DC voltage	0...10 V; Ri = 500 kΩ

Deadband 0.25 % of range span
Setting time 2 s

Accuracy

Deviation according to IEC 484	Class 0.5 referred to range span
--------------------------------	----------------------------------

Variations

Temperature	0.2 % / 10 K, additionally
Humidity	Note infl. on rec. chart acc. to DIN 16234
Auxiliary voltage Hn	0.1 % at 24 V DC ± 20 % 0.1 % at 24 V AC +10 % / -15 % 0.1 % at 110 V AC +10 % / -15 % 0.1 % at 230 V AC +10 % / -15 %
AC interference voltages (see perm. interference voltages)	0.5 % of range span
Magnetic field of external origin 0.5 mT	0.5 % of range span
Mechanical stress according to DIN IEC 68-2-6/27	During and after the effect ± 0.5 % of range span
Transport Impact: 30 g/18 ms Vibration: 2 g/5 ... 150 Hz	
In function Vibration: 0.5 g/± 0,04 mm/ 5...150 Hz/3 × 2 cycles	

Reference conditions

Ambient temperature	25 °C ± 1 K
Relative humidity	45 ... 75 %
Auxiliary voltage	Hn ± 2 %, nominal frequency ± 2 %
Mounting position	Front upright ± 2°
Warm-up time	30 min



Display

Scale

One graduation per measuring system
Scale face 5 mm wide
Character size 2 mm

Recording

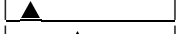
Arrangement of measuring systems and color correlation

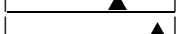
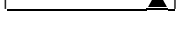
	1	2	3	4	No. of line channels
			×	×	
		×	×	×	
	×	×	×	×	
				×	

1. Line recording

Fiber recording pen with inkwell of approximately 1.4 ml, line length approximately 1300 m, distance between the tips of the fiber recording pens 2 mm.

Recording

Chart speed	Speed selectable on control panel: 1/5/10/20/60/120/240/300/600 mm/h
Recording chart	32 m roll chart or 16 m fanfold chart
Visible chart length	60 mm
Recording width	100 mm (chart width 120 mm, DIN 16230)
Chart intake (with roll chart)	Via automatic paper take-up device (daily tear-off or wind-up of the 32 m possible)

Auxiliary voltage

24 V DC ± 20 %
Power consumption with max. fitting approx. 15 W/20 VA

24/115/230 V AC +10 %/-15 %
Frequency range 47.5 ... 63 Hz
Power consumption with max. fitting approx. 20 W/25 VA

Climatic suitability

Ambient temperature	0 ... 25 ... 50 °C
Transport and storage temperature	-40 ... +70 °C
Relative humidity	≤ 75 % annual average max. RH ≤ 85 % in function
Climatic class	3K3 acc. to IEC 721-3-3

Electrical safety

Test according to DIN EN 61010-1 (classification VDE 0411) and/or IEC 1010-1

Protection class I

Overtoltage category
III at the power input
II at the input

Degree of pollution
2 in the device and in the connection terminals according to VDE 0110 parts 1 and 2

Test voltage
3.75 kV measuring channels to energy supply
2.20 kV protective conductor to energy supply

Functional extra low voltage with protective isolation (PELV according to DIN EN 60950)

Between power input – measuring channels, control leads, interface cables acc. to VDE 0100 part 410 and VDE 0106 part 101

Electromagnetic compatibility

The protection goals of the EMC directive 89/336/EEG as to radio interference suppression according to EN 55011 and as to immunity to interference according to EN 55082-2 are complied with.

Radio interference suppression
Limit class B according to EN 55011 and/or
Post Office decree 243/92.

Immunity to interference: Test according to IEC 801

Type of test	Test severity	Variation	Severity level
ESD (1/30 ns)	6 kV	≤ 1 %	3
HF field			
Radiated 80 MHz ... 1 GHz	10 V/m	≤ 1 %	3
Line-guided 0.15 ... 80 MHz	10 V	≤ 1 %	3
Burst (5/50 ns) on			
Power line	2 kV	≤ 1 %	3
Test lead	1 kV	≤ 1 %	3
Surge (1.2/50 μs) on			
Power line common	2 kV	≤ 1 %	3
Power line differential	1 kV	≤ 1 %	2
1 MHz pulse on			
Power line common	2 kV	≤ 1 %	3
Power line differential	1 kV	≤ 1 %	3

The NAMUR industry standard EMC is met (Interface cables shielded).

Permissible interference voltages

	Perm. interference voltage
Series mode interference voltage peak-to-peak	≤ 0.3 × meas. span max. 3 V
Push-pull rejection	35 dB
Common mode interference voltage	60 V DC/250 V AC
Common mode rejection	83 dB for DC / 96 dB for AC

Connection, case and installation

Electrical connections

Protection type IP 20
Screw-plug terminals for signal inputs
Max. wire cross section 2 x 1 mm²
Screw terminals for line connection
Max. wire cross section 4 mm²

Case

Molded material for installation in panels or mechanical grids (see dimensional drawing for dimensions picture 2)

Protection type of case according to IEC 529

IP 54 for the front
IP 20 for the rear

Color of case

Silica-gray according to RAL 7032

Door of case

Molded material
Option: door with metal frame and glass pane, anti-glare

Fastening of case

With 2 fasteners (optionally for installation in panel or mechanical grid),
max. grid width 40 mm
centering angle brackets are required for installation in mechanical grids, (Ordering Number A416A)

Position of use

Inclined to the side [-30° ... 0 ... +30°]
Inclined to the rear 20°,
Inclined to the front 20°

Mounting distance

Horizontal or vertical 0 mm, it must be possible to open the door of the case through 100°

Weight

3 kg, approx.

6 Packing

The fiber pen inserts must be removed before the recorder is transported.

If the original packaging material is no longer available, wrap the recorder in air-cushion foil or corrugated paper and pack it in a sufficiently large crate which is lined with shock-absorbing material (foam rubber or similar material). The thickness of the padding must be matched to the weight of the device and the type of packaging. The crate must be marked "Fragile".

When shipped overseas, air-tight welding of the recorder into a 0.2 mm thick polyethylene foil which contains a drying agent is additionally required. The quantity of the drying agent is to be chosen in line with the packaging volume and the expected duration of the transport (at least 3 months). The crate must additionally be lined with a layer of double bituminous paper.

Printed in Germany • Subject to change without notice

GOSSEN-METRAWATT GMBH
Thomas-Mann-Str. 16-20
90471 Nürnberg, Germany
Telefon +49 911 8602-0
Telefax +49 911 8602-669
e-mail: info@gmc-instruments.com
<http://www.gmc-instruments.com>

